

NOTICE :	<p>THE OWNER'S MANUAL IS IN TWO VOLUMES:</p> <p>- VOLUME 1 DEALS WITH OPERATING PRECAUTIONS AND SAFETY RECOMMENDATIONS THAT MUST BE OBSERVED.</p> <p>- VOLUME 2 DEALS WITH TECHNICAL SPECIFICATIONS AND ASSEMBLY PROCEDURE OF THE BOAT AND ITS EQUIPMENT.</p>
-----------------	--

	<p>BOATS ARE FUN, AND WE WANT YOU TO ENJOY IT FOR YEARS TO COME. PLEASE SPEND SOME TIME READING YOUR OWNER'S MANUAL AND SAFETY PRECAUTIONS TO UNDERSTAND THE OPERATION AND SAFETY CONSIDERATIONS OF THIS BOAT.</p> <p style="text-align: center;">AND REMEMBER: SAFETY FIRST.</p>
---	---

**VOLUME 1
GENERALITIES - PRECAUTIONS - SECURITY**

CONTENTS



	Page		Page
⇒ Recommendation signs	2	⇒ Handling	
⇒ An important Message - Validity	3	1. mooring and towing	15
⇒ Certification - Identification	4	2. lifting / davits	15
⇒ Manufacturer's ID plate	4-6	3. hauling on trailer	16
⇒ Type of motor and adjustment		⇒ Maintenance	
1. type of motor	7	1. cleaning	17-18
2. type of propeller	7	2. wintering - storage	18
3. installing the motor	8	3. regular verifications	18
4. adjustment	8-9	4. how to repair small punctures	19
⇒ Operating instruction	10-13	5. rigid inflatable boats: small repairs	19
⇒ Environment	14	⇒ Troubleshooting guide	20
		⇒ Warranty - General conditions	21
		⇒ At your service	22

RECOMMENDATIONS SIGNS



Throughout this manual there are advisories of safe operation.

The symbols below are advisories relative to various types of situations.

SECURITY SYMBOLS

 DANGER	DENOTES AN IMMANENT HAZARD WHICH WILL RESULT IN DEATH OR SEVERE INJURY IF NOT AVOIDED.
 WARNING	DENOTES A HAZARD WHICH COULD RESULT IN INJURY OR DEATH IF NOT AVOIDED.
 CAUTION	DENOTES A HAZARD OR UNSAFE PRACTICE WHICH COULD RESULT IN MINOR INJURY OR PRODUCT OR PROPERTY DAMAGE

GENERAL ADVISORY SYMBOLS

	THIS PROCEDURE OR BEHAVIOR COMPLIES WITH THE INSTRUCTIONS.
	THIS PROCEDURE OR BEHAVIOR DOES NOT COMPLY WITH THE INSTRUCTIONS THUS RISKING DAMAGE EQUIPMENT.
NOTICE :	GIVES IMPORTANT INSTRUCTIONS

AN IMPORTANT MESSAGE

Congratulations on your purchase of an inflatable boat. We take pride in bringing you a quality product which will offer you years of pleasure. Your boat is an investment which deserves your care and attention.

This manual has been compiled to help you to operate your craft with safety and pleasure. It contains details of the craft, the equipment supplied or fitted, its systems, and information on its operation and maintenance. Read it carefully, and familiarize yourself with the craft before using it. Serious personal injury and death can occur in and around boats. **To prevent these tragic accidents, please read, understand and strictly enforce all safety rules.**

If this is your first craft, or you are changing to a type of craft you are not familiar with, for your own comforts and safety, please ensure that you obtain handling and operating experience before 'assuming command' of the craft. Your dealer or national sailing federation or yacht club will be pleased to advise you of local sea schools or competent instructors.



- **THIS OWNER'S MANUAL MUST BE ON YOUR BOAT, IN A SECURE PLACE, AND EASILY ACCESSIBLE BY THE PILOT.**
- **KEEP WITH THE OWNER'S MANUAL ALL THE OPERATING MANUALS DELIVERED BY THE MANUFACTURERS OF YOUR BOAT'S EQUIPMENT (MOTOR, BATTERY...)**
- **THIS MANUAL IS PART OF THE BOAT'S STANDARD EQUIPMENT. HAND IT OVER TO THE NEW OWNER IF YOU SELL THE CRAFT.**

VALIDITY AND COMPOSITION

Our commitment to constantly keep pace with the latest advances in technology requires that we reserve the right to change the characteristics or the availability of a boat model for the benefit of our customers.

The information in this manual concerns this boat at the time of issue. This is in no case contractual.

NOTICE :

WE TAKE NO RESPONSIBILITY FOR THE CONSEQUENCES OF ACTIONS NOT COMPLYING WITH THE INSTRUCTIONS GIVEN IN THIS MANUAL.

APPROVAL / CERTIFICATION / IDENTIFICATION

All our boats comply with ISO standard 6185 established by the International Standards Organization, and with the European Directive 94/25/CE modified by the European Directive 2003/44/CE. We are member of NMMA (the US National Marine Manufacturer's Association)

Record below the data indicated on the manufacturer's plate provided on the inside of the transom. You may need them to help identify your boat for insurance purposes in case of theft or for after-sales service.

Carefully record the model (3) and the serial number of your boat, and the ID number provided on the plate outside the transom, near the outboard (XDC) (11).

① Standard plate.

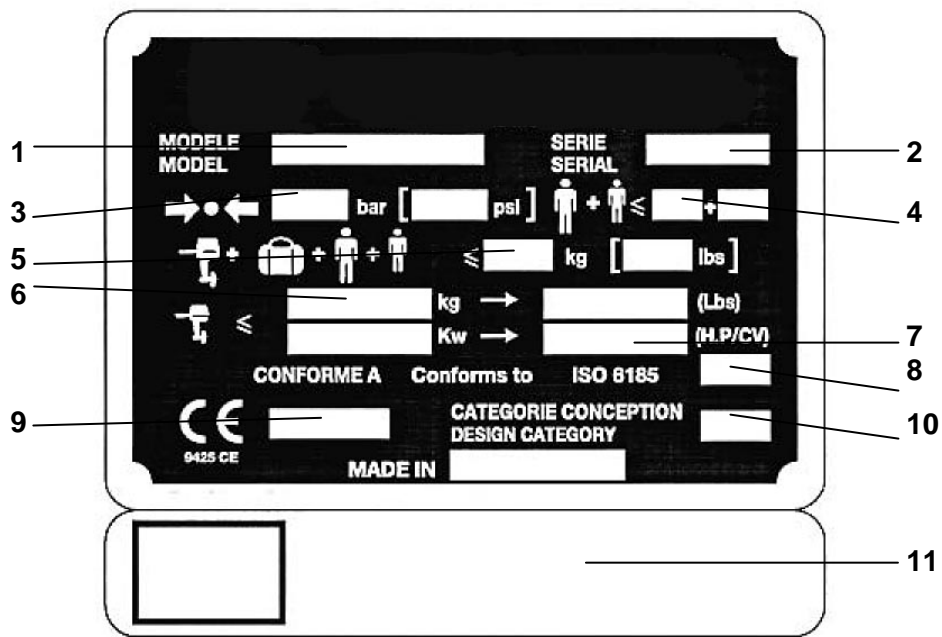

② Plate for a rigid or an inflatable floor.

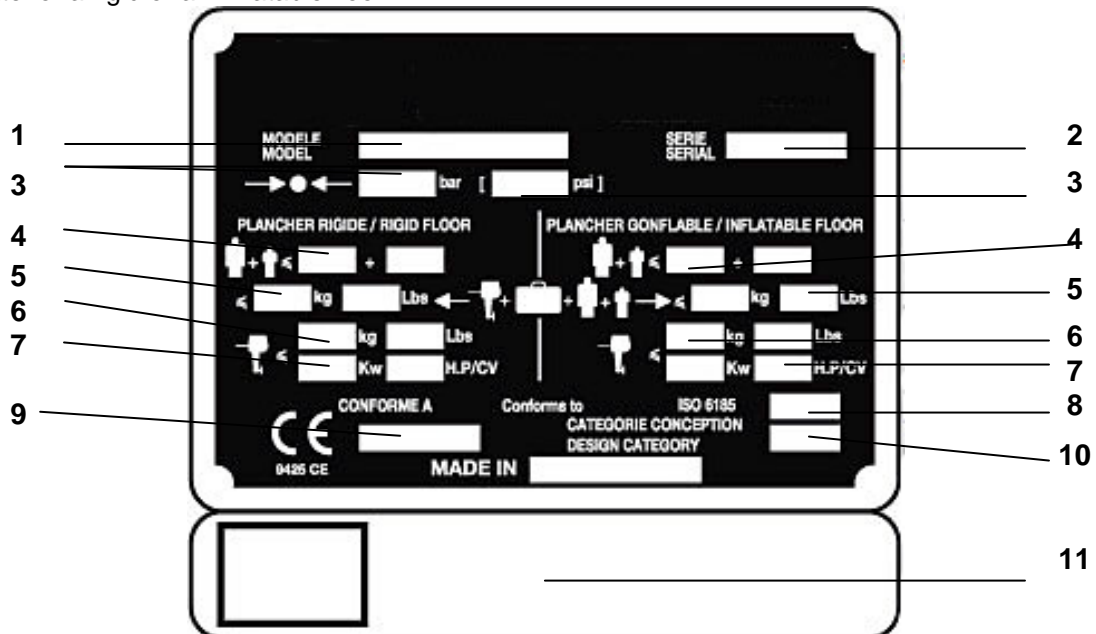

MANUFACTURER'S PLATE

The indications on the manufacturer's plate on the transom are important: they give information about limitations imposed by local or national regulations.

However, **these indications are not a complete list**: the security requirements (obligatory security equipment of the boat, maximum authorized distance you can navigate from a shelter, etc.) may change according to the country or state. **Always refer to local regulations to be informed on additional requirements.**

(1) **MODEL**: Commercial name of the model.

(2) **SERIE**: Boat's serial identification number. Needed for any after-sale service operation and accessories or spare parts purchase.

(3) **Pressure** of the buoyancy tubes in Bars and Psi. Other parts of the boat can require different pressures. Refer to the INFLATION chapter of the Owner's Manual volume 2.

(4) **Maximum number of people authorized on board** (adults + children) according to ISO standards

(5) **Maximum load capacity** of the boat allowed by the constructor expressed in kilograms and in pounds (people + motor and its fuel tank filled to the top + diverse loads).

(6) **Maximum outboard weight** allowed by the constructor for the boat expressed in kilo grams and in Pounds (Lb)

(7) **Maximum outboard power** allowed by the constructor for the boat expressed in kilowatts and in Horse Power (HP)

(8) **ISO Category**:

Your boat complies with ISO 6185 Standard. The engine rating defines its category.

ISO CATEGORY	II	V	VII
Motor rating in kW	0 - 4.5 kW	4.5 - 15 kW	>15 kW
Motor rating in HP	0 - 6 CV/HP	6 - 20 CV/HP	>20 CV/HP

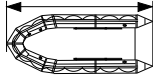

(9) **CE:** ≥ 2.50 m

Sign of the certification to the European directive 94/25/ CE (for overall length > 2.5 m), (followed by the certification organism number and the year of CE certification – for B design category only).

(10) **Design category (European directive 94/25/CE).**

In Europe, your boat has been designed to navigate under different categories:

Category	B	C	D
Navigation	"offshore"	"inshore"	"sheltered waters"
Wind speed (Beaufort scale)	Up to, and including 8	Up to, and including 6	Up to, and including 4
Significant height of wave to consider (H1/3; in meters)	Up to, and including 4	Up to, and including 2	Up to, and including 0,5

(11) **CIN:** small plate with the Craft Identification Number (generally fixed on the external side of the transom;) needed for any after-sale service operation.

 WARNING	<p>BE RESPONSIBLE, TAKE NOTICE OF THESE PARAMETERS WHEN YOU PLAN YOUR NAVIGATION PROGRAM, AND DO NOT PUT TO SEA IF THE CONDITIONS ARE LIKELY TO EXCEED THESE PARAMETERS.</p>
---	---

TYPE OF MOTOR AND ADJUSTMENT

1. TYPE OF MOTOR

1.1 Motor's power

- The maximum and recommended powers are listed in the table of technical specifications (volume 2 of the manual).
- For smaller outboards, go for tiller control, giving direct control over the boat and allowing for quick maneuvering. Above 25 CV/HP, for greater comfort and safety, we recommend that you choose a steering console.

 WARNING	<p>NEVER USE MOTOR POWER HIGHER THAN INDICATED ON THE MANUFACTURER'S ID PLATE: IT COULD ALSO RESULT IN LOSS OF CONTROL, AND YOU WOULD BE BREAKING THE LAW.</p>
---	---

<p>NOTICE :</p>	<p>Where the maximum power exceeds the maximum recommended power it must be treated with extreme care. It is directed at experienced users using their boats for very specific purposes (carrying heavy loads, etc.).</p> <p>It is recommended that you choose your outboards' power in accordance with your principal boating activities.</p> <p>Over-powered your boat can be difficult to control. Under-powered and you may not have that margin of security necessary to go upwind or against the currents.</p>
------------------------	---

1.2 Motor weight

The motor's weight has a great influence on the planning, stability and performances of the inflatable boat. For equal power, we recommend that you choose a light motor.

You must never exceed the maximum authorized motor weight indicated on the manufacturer's plate.

1.3 Motor shaft Length

There are different shaft lengths available for boats. Check which length is required for your boat, and use the proper size (refer to Owner's Manual volume 2).

2. TYPE OF PROPELLER

- In order to choose the optimal propeller for your principal use, your boat and its motor must be tested at sea. Ask your Dealer to assist you.
- In general, the propeller provided with the motor is adapted to all type of navigation. Nevertheless, according to the principal use you intend to make of the boat, go for:

A lower pitch when the boat is heavily loaded or used for water skiing.

A higher pitch that will increase the speed potential (if the boat is lightly loaded).

 DANGER	<p style="text-align: center;">THE PROPELLER IS DANGEROUS.</p> <p style="text-align: center;">KEEP AWAY FROM THE PROPELLER.</p>
--	---

INSTALLING AND ADJUSTING THE MOTOR

3. INSTALLING THE MOTOR

Install the motor along the centreline of the boat, in the middle on the mounting plate (4)
Fully tighten the brackets (1) by hand and check that they are still properly tightened after 15 minutes of running. Secure the motor to the loop (3) on the motor tightening plate (4) with a safety cable (2). All motors above 4 CV/HP are equipped with a security stop switch lanyard (5). Always use it (refer to information contained in the "operating instructions" section)

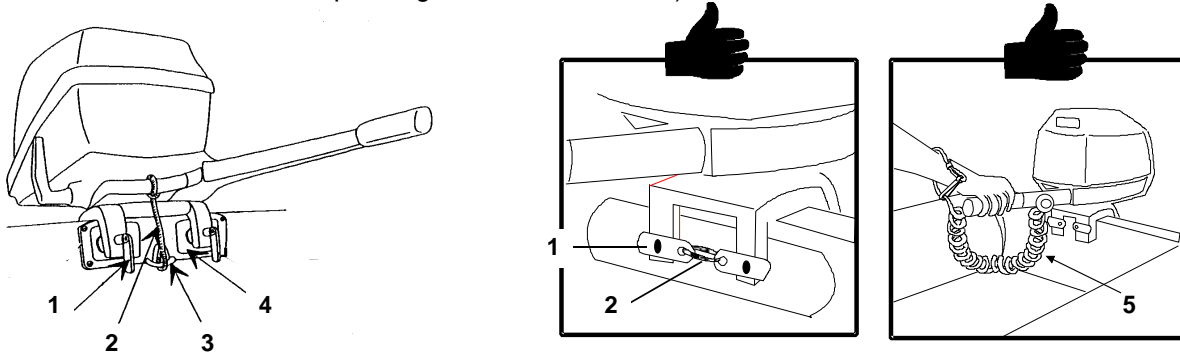

 CAUTION	<ul style="list-style-type: none"> • THE BOLTING OF THE MOTOR TO THE TRANSOM IS SUGGESTED FROM 10 CV/HP AND HIGHLY RECOMMENDED FROM 25 CV/HP AND ABOVE. • FOR ALL OUTBOARDS FROM 25 CV/HP AND ABOVE WE RECOMMEND THE INSTALLATION OF A REMOTE STEERING UNIT.
---	--

 WARNING	<ul style="list-style-type: none"> • FOR OUTBOARDS NOT BOLTED TO THE TRANSOM: REGULARLY CHECK THAT THE BRACKETS STAY PROPERLY TIGHTENED. • FOR OUTBOARDS WITH REMOTE STEERING UNIT: REGULARLY CHECK IT IS IN GOOD WORKING ORDER, AND CHECK THE TIGHTENING OF THE NUT CONNECTING THE STEERING SYSTEM TO THE MOTOR.
---	---

NOTICE :	Bolting is to be done once the motor is evenly positioned. Have the motor bolted to the transom by your dealer.
-----------------	--

4. ADJUSTMENTS

The motor requires a double position adjustment in tilt and height that greatly and directly impacts on the boat's attitude. You will have to adjust the motor in height only once.

On the contrary, to optimize performances and good maneuverability, you will have to adjust the angle of the motor in relation to the transom depending on the navigation conditions:

4.1. Motor height

The motor is mounted on the transom. According to different brands of motors, even inside the same type of shaft, the length of the shaft can vary (few centimeters). It is generally necessary to add a shim to ensure correct height.

Motor adjusted too high = ventilation may occur with loss of forward thrust (cavitation).

Motor adjusted too low = loss of speed and more difficult steering may occur (splashes).

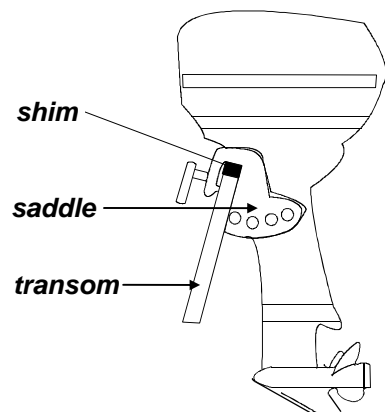

ADJUSTING THE MOTOR

4.2 Motor position (TRIM)

As a rule, the motor must be positioned so that the axis of the propeller is parallel with the water surface.

However, an adjustment of the tilt is often recommended (see the chapter *Operating instructions* of this manual).

The adjustment of the tilt can be manual or assisted by an electric Trim (when equipped).

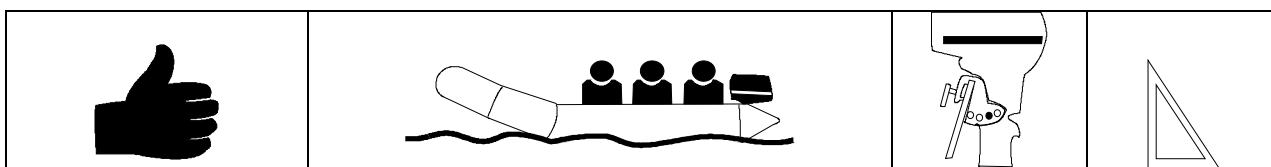

ENGLISH

	<p>Motor tilted outwards too far from the transom: the boat will porpoise.</p>
	<p>Motor tilted inwards too near the transom: the boat will nose down.</p>

 WARNING	MAKE MODIFICATIONS ON THE TRIM WITH MOTOR SHUT OFF.
--------------------	--

NOTICE :	For specific information concerning the motor itself, refer to the motor's manual.
-----------------	--



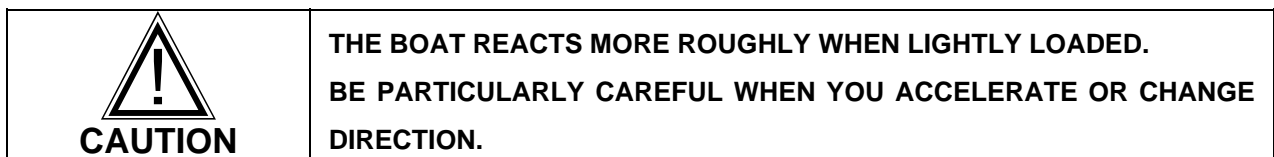
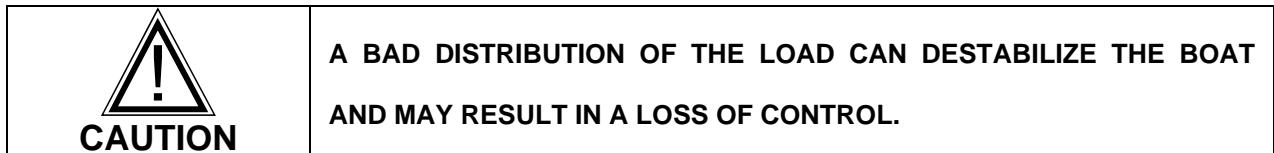
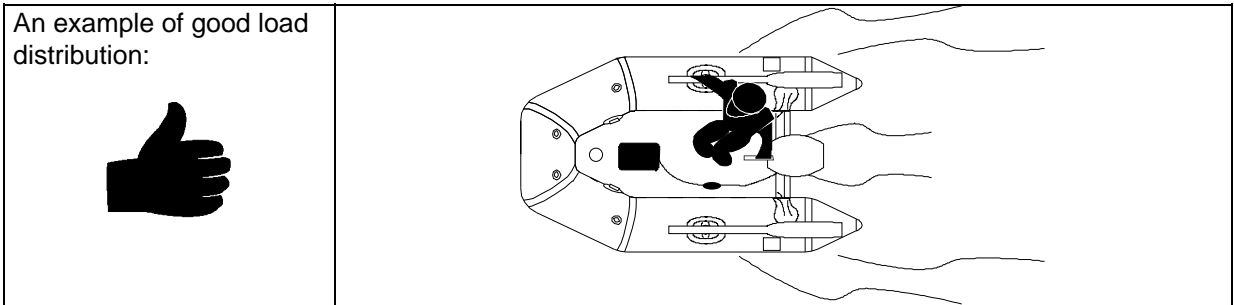

OPERATING INSTRUCTIONS

Distribution of the load

- Evenly distribute the load. (For example, fixing the fuel tank on the front can help to offset the weight of the outboard).
- To counterbalance the effects of the propeller's rotation sense on the comportment of the boat, we recommend that the pilot remains on the starboard side.

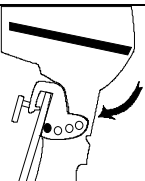

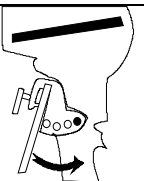
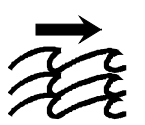
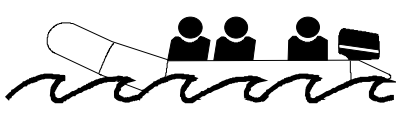
Depending on the navigation conditions and the waves direction, you must adjust the distribution of the load and the Trim.

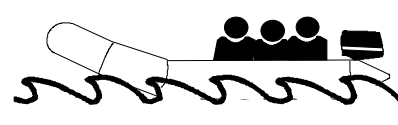
<p>in a "head on" sea, - load the bow - the tilt pin should be in the 2nd or the 1st hole position</p> <p>Negative TRIM</p>		<p>in a "following" sea, - load the stern - the tilt pin should be in the 3rd or the 4th position</p> <p>Positive TRIM</p>	
			
			

OPERATING INSTRUCTIONS

SAFETY FIRST: LEARN HOW TO AVOID ACCIDENTS

CHECK-LIST BEFORE DEPARTING



GET REQUIRED INFORMATION AND INFORM OTHER PASSENGERS:

- GET INFORMED** on local regulations and hazards related to water activities and boat operation.
- CHECK** weather forecast, local currents, tides and wind conditions.
- ADVISE** someone on land of the time you plan to be back.
- EXPLAIN** basic boat operation to all passengers.
- BE SURE** that one of your passengers can operate the boat in case of emergency.
- LEARN** how to determine the distance you can cover with a full fuel tank, and remember that bad weather conditions can alter this. Always be sure you have enough fuel to reach a shelter.

CHECK THE GOOD WORKING OF THE BOAT AND EQUIPMENT:

- CHECK** inflation pressure.
- INSPECT** the valves caps. Remove the self bailer plug.
- CHECK** the tightening of the motor clamps. If it is not bolted, don't forget to secure the engine with a safety lanyard attached to the bracket and the motor plate.
- BE SURE** the safety stop switch lanyard operates correctly.
- TOP OFF** fuel and oil level.
- DO NOT FORGET** to fill up the oil level if your motor has a separate oil tank.
- CHECK** the security of your fuel tank. Install it at the spot provided.
- BE SURE** motor is not in gear before starting.
- CHECK** the load is evenly distributed (see chapter OPERATING INSTRUCTION).

CHECK that required safety equipment is on board:
(Check the laws and regulations of the country or locality in which you are boating).

- One personal flotation device (PFD) per person.
- The foot-pump, paddles (or the oars), repair kit and tool kit.
- The mandatory equipment.
- The boat papers and your boating license.
- Lights are required if operating after dark.

OPERATING INSTRUCTIONS

SAFETY FIRST: LEARN HOW TO AVOID ACCIDENTS

RULES TO OBSERVE DURING NAVIGATION

- Be responsible: do not neglect the safety rules, this could jeopardize your life and the lives of others.
- Learn to always keep control of your boat.
- Always operate with courtesy and respect.
- Respect local regulations and practices.
- Near the shore, navigate in the designated boating areas.
- At sea, weather conditions can rapidly deteriorate. Always be sure that you can reach a shelter rapidly.



- USE PERSONAL FLOTATION DEVICE (PFD):** PFD are required equipment. Wear them.
- ALWAYS USE THE STOP SWITCH LANYARD:** Your outboard comes equipped with a stop switch safety lanyard to prevent a runaway boat in case the operator falls overboard. Wear it around your wrist or affix to the clothes you are wearing.
- NO ALCOHOL / DRUGS :** Do not drink alcohol or take drugs before or while operating your boat. Maintain passenger sobriety.
- DO NOT EXCEED THE AUTHORIZED NUMBER OF PERSONS OR WEIGHT.**
- MAKE SURE YOUR PASSENGERS REMAIN SEATED:** Sitting on the buoyancy tubes may be comfortable at rest or at low speeds provided your passengers use the grab line. At planning speeds, in rough water or during sharp turns, all passengers should position themselves in seats (standard or option) or on the floor.
- NO BOW RIDING:** Bow riding is illegal in most areas and is extremely dangerous: in case of falling, the man overboard is in the way of the propeller.
- BE ESPECIALLY CAREFUL WHEN DOCKING:** Arms and legs may be injured if they are outside the boat.
- KEEP CLEAR OF SWIMMERS AND DIVERS:** Always avoid areas where divers/swimmers are in the water. Keep a sharp lookout especially when operating near beaches and launch sites. Shut off the motor when operating near someone in the water. The Alpha flag indicates proximity of divers. You **MUST** stay at a good distance (minimum 50 meters).
- AVOID SHARP TURNS AT HIGH SPEEDS:** You could get ejected from the boat.
- DO NOT** make a brutal change in direction without advising passengers.

OPERATING INSTRUCTIONS

SAFETY FIRST: LEARN HOW TO AVOID ACCIDENTS

RULES TO OBSERVE DURING NAVIGATION

 <p>WARNING</p>	<ul style="list-style-type: none"><input checked="" type="checkbox"/> BATTERY:<ul style="list-style-type: none">- Avoid sparks and open flames near battery (hydrogen gas from battery may explode).- Do not allow contact between positive and negative poles.- Turn off engine before inspecting or servicing battery.<input checked="" type="checkbox"/> BEWARE : Avoid all contact between the buoyancy tubes and sharp objects or aggressive liquids (such as acid).<input checked="" type="checkbox"/> INSPECT AND MAINTAIN STEERING SYSTEM: An improperly maintained system may fail, causing sudden loss of control.<input checked="" type="checkbox"/> AVOID THE RISKS OF EXPLOSION OR FIRE HAZARDS: Ensure your fuel system is in a good order and maintain it properly.<input checked="" type="checkbox"/> AVOID SMOKING ON BOARD and most particularly while filling the fuel tank.<input checked="" type="checkbox"/> IF FUEL HAS SPILLED ON THE FLOOR: wash off with water.
---	--

**E
N
G
L
I
S
H**

IN CASE OF ACCIDENT

In case of accident, do not panic, and reassure passengers. Be aware that the boat, even damaged, is often the best shelter and facilitates your rescue.

An inflatable boat is practically unsinkable, even full of water. If after an accident, a compartment deflates, bring it inside the boat, restore the load balance to the opposite side of the deflated compartment and return at reduced speed. In case of a collision or an impact with a floating object, stop to examine the hull, the buoyancy tubes, the motor and its attachments and return to shore at a low speed.



Take your boat to your Dealer for inspection before using it again.

 <p>WARNING</p>	<p>NEGLECTING INSPECTIONS AND REPAIRS MAY LEAD TO A SERIOUS INJURY AND WILL REDUCE THE LIFE OF YOUR BOAT.</p>
---	--

ENVIRONMENT

RESPONSIBLE BOATING BEGINS WITH YOU

With your inflatable boat, you can discover the richness of the marine environment. Help keep it beautiful. Enjoying some time on the water is great, but it comes with some responsibility for us all to work to ensure that the world around us remains a strong healthy environment for living and play. Please, respect your environment by applying the following basic safety rules:

	<ul style="list-style-type: none"> <input checked="" type="checkbox"/> AVOID CREATING EXCESSIVE WASH. <input checked="" type="checkbox"/> KEEP OUT OF DESIGNATED SWIMMING AREAS. <input checked="" type="checkbox"/> RESPECT ALL ANIMAL LIFE. Respect the laws for bag limits and practice catch and release sportsmanship. <input checked="" type="checkbox"/> USE NON-POLLUTING ANTI-FOULING PAINT AND NON POLLUTING CLEANING AGENTS. <input checked="" type="checkbox"/> BE CAREFUL NOT TO OVERFILL THE FUEL TANK: the surplus would go into the sea.
	<ul style="list-style-type: none"> <input checked="" type="checkbox"/> DON'T MAKE UNNECESSARY NOISE. Excessive noise should be avoided, particularly around launching ramps and populated areas. <input checked="" type="checkbox"/> DO NOT DISCHARGE OIL OR FUELS INTO THE WATER. In most areas this is illegal and in all areas it causes pollution and harms plant and animal life. <input checked="" type="checkbox"/> DO NOT LITTER. Dispose of garbage and trash properly. if there is no appropriate refuse disposal, bring back your trash. <input checked="" type="checkbox"/> DON'T MAKE EXCESSIVE WAKE. Remember that the wake your boat trails behind can be destructive to the shore, as well as to other boaters. A boat wake crashing on the shore can cause and accelerate erosion and damage the environment.

The health of your environment depends on us all acting responsibly to ensure a clean tomorrow. If each of us follows these few simple rules, we can help to keep the Earth's resources intact for future generations.

To respect the environment, we have printed this manual on non-chloride recycled paper.

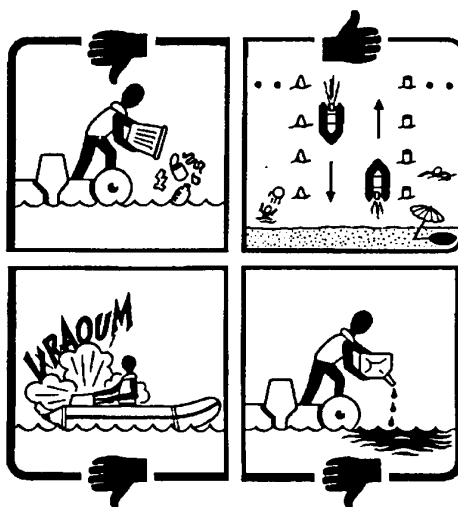

HANDLING

1. MOORING AND TOWING

1.1. MOORING

Fully inflatable boats: Use the buoyancy tubes' lateral D-rings.

Rigid inflatable boats: Use the hull's mooring ring.

NOTICE :	When moored, the self bailers should remain open to drain the rain water.
-----------------	--

1.2. TOWING

Fully inflatable boats should always be towed using a bridle; use the 2 lateral D-rings (fixed on the buoyancy tubes) made for this purpose.

For rigid inflatable boats (RIB), use a single line attached to the mooring ring.

Towing the fully inflatable boats:

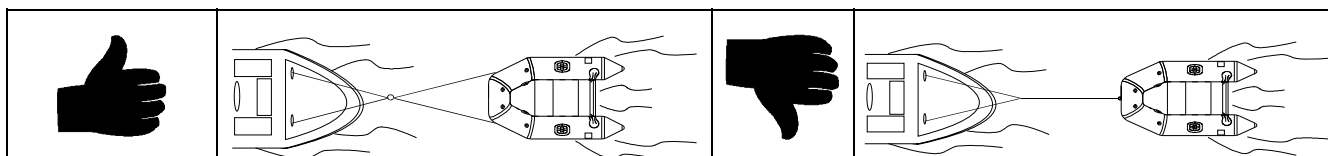

Towing the rigid inflatable boat.

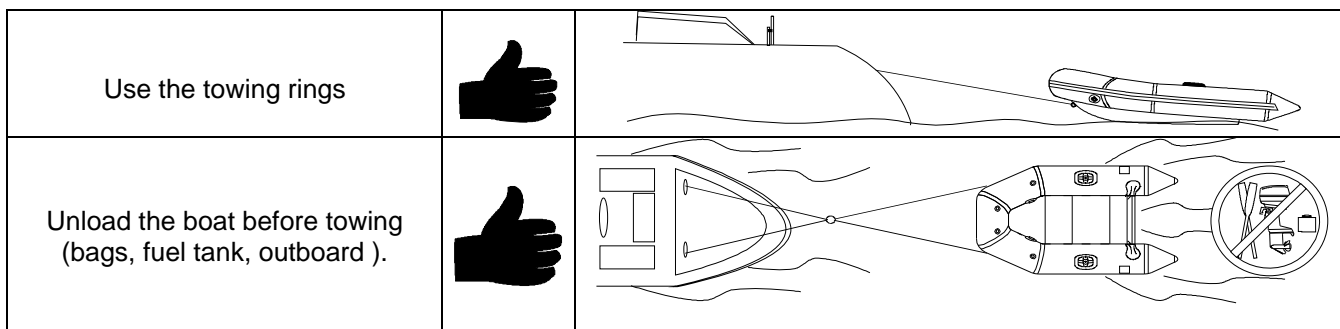

NOTICE:	Towing must be done at low speed and in good weather conditions.
----------------	---

1.3 Mooring to a pontoon

The boat can be moored to a pontoon with at least two mooring lines: one fixed on the bow and one on the stern.

The mooring rope can be fastened on a fixed and strong point on the boat:

RIBS: Cleat, towing ring, mooring bitt, U-bolts (Do not use points not intended for this purpose: Bolt rope, handle, guard rail, handrail, D-rings.. .)

- Foldable boats and tenders: Cleat, U-bolts, suspension brackets, bow handles (Do not use points not intended for this purpose: Bolt rope, carrying handle, D-rings...).

The boat must be protected from rubbing against the pontoon by fenders.

Mooring lines should not rub against the tube. Should the configuration not allow to avoid this, the tube must be protected in areas of friction (Thick fabric or hose around the mooring rope, for example).

Any boat moored to a pontoon should be regularly watched and the mooring lines may need to be strengthened according to the weather conditions.

2. LIFTING - DAVITS

To hoist your boat and place it on davits, use the davit lifting rings (have them installed by your agent if your boat is not equipped).

 WARNING	NOBODY ON BOARD DURING THE LIFTING
 CAUTION	WHEN BEING HOISTED OR PLACED ON DAVITS, THE BOAT MUST BE EMPTY (NO EQUIPMENT) AND TIPPED TOWARD THE REAR. SELF BAILERS SHOULD REMAIN OPEN TO DRAIN THE RAIN WATER.

HANDLING

3. HAULING ON TRAILER

- The boat must be properly inflated.
- The self bailer should remain open.

3.1 Fully inflatable boats :

- Adjust the rollers (or supports) (1) of the trailer to fit the shape of the boat.
- Haul the boat onto the trailer using the lateral D rings.
- The bottom of the transom must rest on the trailer bunks.
- Place the motor in the down or trailing lock position so that it can rest on the support provided on the trailer (3).
- Check that the boat lies flat and secured on the trailer bunks and cannot move.

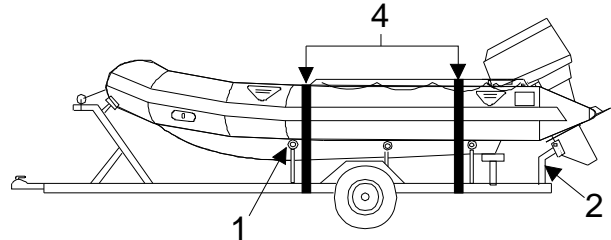

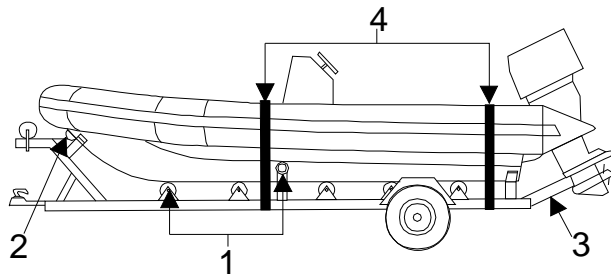

3.2 Rigid inflatable boats :

- Adjust the rollers -or supports- (1) of the trailer to fit the hull.
- Haul the boat onto the trailer using the mooring ring (2).
- Check if the boat is stable.
- Place the motor in the down or trailing lock position so that it can rest on the support provided on the trailer (3).



- Tie down the straps and ensure the buoyancy tubes are protected against chafing (4).
- Following the traffic rules you have to protect the propeller with a cover.
- Every thing must be removed or secured to avoid flying away.

 CAUTION	<ul style="list-style-type: none"> • A BAD POSITION OF THE BOAT ON THE TRAILER MAY RESULT IN DAMAGE TO YOUR BOAT AND EQUIPMENT. • NEVER EXCEED THE TRAILERS' AUTHORISED WEIGHT CAPACITY.
---	--

 WARNING	<ul style="list-style-type: none"> • ON THE ROAD: BOAT MUST BE EMPTY OF LOOSE EQUIPMENT WHEN TRANSPORTED ON TRAILER. • NOBODY ON BOARD DURING TRANSPORTATION ON TRAILER.
---	--

MAINTENANCE

The buoyancy tube of your boat is made of fabric using plastomer. Maintenance is easy but essential for the longevity of your boat.

1. CLEANING

1.1 Clean your boat often, and obligatory before wintering.

	NEVER USE HIGH PRESSURE CLEANING EQUIPMENT LIKELY TO DAMAGE THE BOAT.
---	--

Inflate the buoyancy tube

- Open the self bailer and wash the boat with a hose to remove sand and other particles.
- Clean with soap and fresh water frequently , once a month during the period of use at least .
- Remove all traces of tar (use the ACCESS product from your Dealer if required).
- Check the tube and high pressure air floor for leaks, with foamy soap and water.
- Rinse with fresh water and dry thoroughly.

	NO STRONG DETERGENTS (ACID, TRICHLORETHYLENE...), SILICONE-BASED PRODUCTS OR LIKE AGENTS TO BE PLACED ON TUBES. IF A SPILL OCCURS, WASH OFF WITH WATER.
---	--

When deflating

- Check that the valves and gaskets are clean and not damaged.
- Check the self bailer is not clogged.

1.2 Check airtightness of your boat:

NOTICE:	<p>LOSS OF PRESSURE</p> <ul style="list-style-type: none"> • Loss of pressure over 24 hours is not unusual. (ISO 6185 standard permits a certain amount of pressure loss). Add air as necessary. If loss of pressure exceeds 10 mb (0,14 PSI) /5 hours for buoyancy tube, and 35 mb (0,49 PSI) /5 hours for high pressure air-floor: Check airtightness of your boat. • Temperature has a great influence on air pressure. A variation of 1°C results in a variation in the same way of about +/- 4 mb (0,06 PSI). If you have a problem with an air leakage: first, check all valves are intact and in closed position (nothing clogging valve). Do not hesitate to contact your Dealer.
----------------	--

1.3. FOR RIGID INFLATABLE BOATS : CLEANING OF THE HULL.

- Remove buoyancy tube (for boats with removable buoyancy tubes).
- Wash the deck and hull with clear water and soap. Dry thoroughly.
- Check the self bailer is not clogged.
- Open the drainage holes caps to evacuate water.
- Reassemble the tube to the hull if necessary and inflate.

MAINTENANCE

1.4 Maintenance of stainless steel

We use only top quality stainless steels, which are resistant to corrosion. However, salt water is a harsh environment and maintenance is required to avoid corrosion.

NOTICE:	Stainless steel is not permanent <ul style="list-style-type: none">. Avoid contamination that results of contact with iron tools: Use chromed tools.. Avoid scoring its surface.. Frequently wash with fresh water.. Grease or polish it regularly and restore it with an appropriate product (ask your Dealer).
----------------	--

1.5 Maintenance of the seats and marine plywood floor

Wash the seats and floor with soap and fresh water, and dry thoroughly..
Paints and varnishes not only are decorative elements, they also protect the materials.
As soon as you see flakes or scratches on the surface, have it repainted using polyurethane - based products.

2. WINTERING - STORAGE

When storing your boat, keep it in a clean and dry place that is not affected from major variations in temperature and other damaging factors. You may store the boat:

- Deflated and rolled up in its bag.
- Assembled and lightly inflated.

	<ul style="list-style-type: none">• FOR LONG TERM STORAGE IN THE SUN (ESPECIALLY IN TROPICAL REGIONS), PROTECT YOUR BOAT WITH A BREATHABLE CANVAS COVERING.• RODENTS CHEW ON FABRIC INCLUDING INFLATABLE BOAT MATERIAL. STORE AWAY FROM RODENTS.• IF YOU CHOOSE TO STORE YOUR BOAT INFLATED, MAKE SURE YOU DO NOT SUBJECT IT TO DEFORMATIONS.
---	--

3. REGULAR INSPECTIONS:

- Check frequently the signaling, straps and halyards. Replace used elements.
- Check frequently the tightness of the screws and nuts, particularly the motor's bolting to the transom. Remember that on some rigid inflatable boats, the plate supporting the motor is also bolted to the hull.
- Regularly examine your fuel system, replace old damaged elements and check the tightness of the clamping rings.

MAINTENANCE

4. HOW TO REPAIR SMALL PUNCTURES

REPAIR KIT	<p>Cleaning :</p> <ul style="list-style-type: none"> - Grease remover of the alcohol type. <p>Repairing:</p> <ul style="list-style-type: none"> - Patch. - Tube of special glue, ready for use (carefully replace the cap on the tube of glue. If properly sealed, it keeps perfectly). - Brush.
CONDITIONS NECESSARY FOR SUCCESSFUL REPAIR	<ul style="list-style-type: none"> - Relative humidity less than 60%. - Temperature between 18 and 25°C. - Avoid carrying out repairs : <ul style="list-style-type: none"> . in direct sunlight . in rain - Check that the buoyancy tube is fully deflated and lies flat.
PREPARATION	<ul style="list-style-type: none"> - Cut out a round patch at least 5 cm larger than the cut. - Clean the damaged part of the boat and the corresponding side of the patch with a grease remover of the alcohol type. - Draw the shape of the patch exactly where it will be applied. - Allow to dry for 5 minutes.
GLUING	<ul style="list-style-type: none"> - Apply 3 thin layers of glue on both the patch and the roughened area on the boat and let dry for 5 minutes between each layer until tacky.
PUTTING ON THE PATCH	<ul style="list-style-type: none"> - When the 3rd layer is dry, apply the patch without pressing and adjust the position if required. - Press out the air bubbles which may have formed under the patch. - Smooth the patch with a round object (ex: a spoon) starting from the center of the patch. - Clean the excess glue with a solvent.
USE OF BOAT AFTER REPAIR	<ul style="list-style-type: none"> - Do not expose the repair to sun or rain. - Let dry for 24 hours before inflating.
 CAUTION	<ul style="list-style-type: none"> - Do not leave the tube in the sun or next to heat sources or direct flames. - Always work in a ventilated area, avoid inhaling glue vapors or swallowing it. Avoid contact with the skin or the eyes.

5. RIGID INFLATABLE BOATS: SMALL REPAIRS ON THE HULL

- The small scratches can be reduced or removed with polish or other appropriate products.
- The deeper scratches can be repaired with polyester mastic. In this case, ask your dealer.

NOTICE:	FOR MAJOR REPAIRS, TAKE YOUR BOAT TO A DEALER WHO CAN PERFORM AFTER SALES SERVICE.
----------------	---

TROUBLESHOOTING GUIDE

INDICATION	PROBABLE CAUSE	CORRECTIVE ACTION
Boat Trim is bow down / running flat	Load not evenly distributed	Distribute the load evenly
Boat Trim is bow up	Wrong motor Trim	Adjust motor Trim
The motor revs during turns	Cavitation / Ventilation Motor too high	Adjust motor height
Excessive spray	Motor too low	
Too much water in the boat	Self bailers closed or clogged	Open and clean self bailers
Noticeable drop in the general pressure of the buoyancy tube	Noticeable decrease in outside temperature	Inflate the buoyancy tube
Noticeable drop in the pressure of one of the buoyancy tube chambers	Bad sealing of valve or valve cap	Clean valve or valve cap / Change sealing washer
	Leak or tear in buoyancy tube	Locate and repair the leakage

WARRANTY - GENERAL CONDITIONS

NOTICE :	<p>YOUR BOAT IS DELIVERED WITH A WARRANTY CARD THAT DETAILS THE TYPE AND MODEL NUMBER OF THE BOAT. THIS CARD ALSO CONTAINS IMPORTANT INFORMATION NECESSARY FOR WARRANTY'S VALIDATION..</p> <p>YOU MUST COMPLETE IT AND SEND IT TO THE DESIGNATED ADDRESS TO REGISTER YOUR WARRANTY.</p>
-----------------	---

Please refer to the conditions in the warranty card supplied with the boat.

The main limitations to the application of this warranty are the following :

- The boat must not be modified and/or fitted with a motor in excess of that allowable by the manufacturer or used in any activities outside normal recreational use (such as races, professional usage)
- Use in excess of the manufacturers recommended maximum load capacity
- Pressure recommendations, assembly/disassembly and handling procedures must be strictly observed
- The maintenance and the storage conditions must not be neglected
- This warranty does not cover parts and accessories not supplied or recommended by the manufacturer or defects resulting from the installation of such equipment on their products.

NOTICE :	ALL REPAIRS COVERED BY WARRANTY MUST BE PERFORMED BY AN AUTHORIZED DEALER.
-----------------	---

 WARNING	<p>YOUR BOAT IS DESIGNED IN ACCORDANCE WITH THE STANDARDS FOR A SPECIFIC USE. ANY MODIFICATIONS, TRANSFORMATIONS OR USE OF A MOTOR HORSE POWER HIGHER THAN MAXIMUM ALLOWABLE BY THE MANUFACTURER COULD RESULT IN SERIOUS RISKS FOR THE USER AND WILL VOID THE WARRANTY.</p>
---	---

